

Dyness

HOME ENERGY STORAGE SOLUTIONS



DYNNESS

Discover Your Nature

 Discover Your Nature

Address: Guoxiang Residential District Liupu Road No.688 Block 5,Wuzhong,Suzhou,Jiangsu,China
Email: sales@dyness-tech.com
Tel: +49 611 76034047
Web: www.dyness.com

www.dyness.com

About Dyness

Dyness, founded in 2017, is a global pioneering energy storage system solutions innovator. Relying on advantageous technology and robust product R&D capabilities, Dyness has established a comprehensive product portfolio for full scenarios, including C&I and residential energy storage throughout the entire lifecycle. With its global headquarters in Suzhou City, China, Dyness has provided safe, reliable, and high-quality products and services to over 500,000+ users in 100+ countries and regions.

At Dyness, customer satisfaction is always Dyness' top priority. Aligned with its mission to reduce the Earth's temperature, Dyness is collaborating with 90+ global brand partners to reduce the cost of renewable energy usage for users. As the pace of global energy transition accelerates, Dyness is committed to promoting sustainable development on a global scale through commercial deepening. It strives to work alongside the industry, market and society to build a low-carbon future worldwide.



100+
Global Markets



150+
R&D Staff



2
Production Centres



120+
IPRs

Dyness Home Energy Storage Solution

1

DYNESS Battery:

Store excess solar and use it to balance house consumption and power supply. Provide backup power for your home during blackout.

2

Inverter:

Matching with leading inverters.

3

Cooperate with APP to realize Rapid Shutdown of solar panels on roof.



Product overview

Trusted Residential Energy Storage Solutions



Reliable Low Voltage Home Energy Storage Systems

25.6~51.2V

B4850/B4850-BOX/DL3.6/B3/DL2.5/DL5.0/DL5.0C/A48100/

PowerDepot H5B/Powerbox Pro/Powerbox G2/PowerBrick

2.4-14.33kWh





B4850-BOX



High Protection Level

IP54 protection level, waterproof and dustproof, easy to cope with indoor and outdoor application scenarios.



Various Installation Methods

Can be floor-standing or wall-mounted to satisfy different installation requirements.



Simple Battery Installation

The battery can be directly inserted and simply installed, and its top cover is fixed with strong magnetic suction instead of screws.



Higher Battery Capacity

It features up to 4.8kWh capacity to meet customers' power demands.

Technical Specifications

Model	B4850-BOX
Number of Batteries	2
Battery Type	LiFePO4
Nominal Battery Energy	4.8kWh
Nominal Capacity	100Ah
Nominal Voltage	48V
Operating Voltage	42 ~ 54.75V
Recommended C Rate	0.5C
Recommended Charge/Discharge Current	50A
Max. Power Charge/Discharge Current	100A
Peak Power Charge/Discharge Current	110A(Protect)
Depth of Discharge	90%
Net Weight	53kg
Dimension[W x D x H]	507 x 216 x 457mm
Charging Temp. Range	0 ~ 55°C
Discharging Temp. Range	-20 ~ 55°C
Communication	CAN/RS485
Cycle Life ^[1]	≥6000 Cycles
Protection Level	IP54

[1] Test conditions: 0.2C Charging/Discharging, @25°C, 90% DOD



B4850

The DYNESS battery B4850 module is widely used in energy storage sector. It adopts modular design and can be used for residential applications. The reliable LiFePO4 technology ensures maximum safety and a longer life cycle.



Module Design

Flexible expansion



Easy Installation

Stackable with flexible brackets



High Safety LFP

Cell level monitoring and balancing



Wide Compatibility

Matching with leading inverters

Technical Specifications

Model	B4850
Battery Type	LiFePO4
Nominal Battery Energy	2.4 kWh
Nominal Capacity	50Ah
Nominal Voltage	48V
Operating Voltage	42 ~ 54.75V
Recommended Charge & Discharge C Rate	0.5C
Recommended Charge/Discharge Current	25A
Max. Power Charge/Discharge Current	50A
Peak Power Charge/Discharge Current	55A (Protect)
Depth of Discharge (DOD)	90%
Net Weight	22 kg
Dimension[W*D*H]	480*360*90mm/480*405*90mm
Charging Temp. Range	0~55°C
Discharging Temp. Range	-20~55°C
Communication	CAN/RS485
Cycle Life ^[1]	≥6000 Cycles
Protection Level	IP20
Expansion	Up to 40 units in parallel
Pros	Can be used in both off-grid and hybrid setups, compact design
Certification & Safety Standard	UN38.3/CE-EMC/IEC62619/IEC62040/CEC Accredited/CEI-021/UL1973/REACH/ROHS/UKCA/GOST-R
Compatible Inverters	SMA/Victron/Ingeteam/Delios/Goodwe/Solis/Deye/SAJ/Voltronic/Sungrow etc.

[1] Test conditions: 0.2C Charging/Discharging, @25°C, 90% DOD



B3

With a 19" inch modular design and built-in intelligent BMS protection system, Dyness B3 enables flexible expansion and easy installation & maintenance. It adopts LiFePO4 technology for maximum safety and longer cycle life.



Module Design
Flexible expansion



Easy Installation
Stackable with flexible brackets



High Safety LFP
Cell level monitoring and balancing



Wide Compatibility
Matching with leading inverters

Technical Specifications

Model	B3
Battery Type	LiFePO4
Nominal Battery Energy	3.6 kWh
Nominal Capacity	75Ah
Nominal Voltage	48V
Operating Voltage	42 ~ 54.75V
Recommended Charge & Discharge C Rate	0.5C
Recommended Charge/Discharge Current	37.5A
Max. Power Charge/Discharge Current	50A
Peak Power Charge/Discharge Current	55A (Protect)
Depth of Discharge (DOD)	90%
Net Weight	31 kg
Dimension[W*D*H]	480*360*130 mm
Charging Temp. Range	0~55°C
Discharging Temp. Range	-20~55°C
Communication	CAN/RS485
Cycle Life ^[1]	≥6000 Cycles
Protection Level	IP20
Expansion	Up to 40 units in parallel
Pros	Can be used in both off-grid and hybrid setups, compact design
Certification & Safety Standard	UN38.3/CE-EMC/IEC62040/IEC62619/GOST-R/UKCA/CEC Accredited/CEI-021
Compatible Inverters	SMA/Victron/Ingeteam/Delios/Goodwe/Solis/Deye/SAJ/Voltronic/Sungrow etc.

[1] Test conditions: 0.2C Charging/Discharging, @25°C, 90% DOD



DL3.6

DYNESSE DL3.6 is low-voltage energy storage product which adopts high safety LFP technology. With 3.6 kWh each, it can support up to 180 kWh with 50 modules connected in parallel. It also supports remote update & easy monitoring. Meet this efficient product with perfect performance.



APP Monitoring (optional)
Real-time monitoring & Remote upgrade



Module Design
Flexible expansion



Easy Installation
Stackable with flexible brackets



High Safety LFP
Cell level monitoring and balancing



Wide Compatibility
Matching with leading inverters

Technical Specifications

Model	DL3.6
Battery Type	LiFePO4
Nominal Battery Energy	3.6 kWh
Nominal Capacity	75Ah
Nominal Voltage	48V
Operating Voltage	42 ~ 54.75V
Recommended Charge & Discharge C Rate	0.5C
Recommended Charge/Discharge Current	37.5A
Max. Power Charge/Discharge Current	75A
Peak Power Charge/Discharge Current	100A (15s)
Depth of Discharge (DOD)	90%
Net Weight	32.5 kg
Dimension[W*D*H]	480*405*132 mm
Charging Temp. Range	0~55°C
Discharging Temp. Range	-20~55°C
Communication	CAN/RS485/RS232
Cycle Life ^[1]	≥6000 Cycles
Protection Level	IP20
Expansion	Up to 50 units in parallel
Pros	Can be used in both off-grid and hybrid setups, compact design
Certification & Safety Standard	UN38.3/CE-EMC/IEC62619
Compatible Inverters	SMA/Victron/Ingeteam/Delios/Goodwe/Solis/Deye/SAJ/Voltronic/Sungrow etc.

[1] Test conditions: 0.2C Charging/Discharging, @25°C, 90% DOD



DL5.0 has a larger capacity design for residential and commercial storage applications. Up to 50 batteries can be connected in parallel to meet the needs of more users. The optional OTA function enables remote update & easy monitoring. Powerful, high capacity and modular.



Dyness DL2.5 is a good alternative for lead acid battery and a perfect match for off-grid applications in areas with limited or no grid access. It is scalable from 2.56kWh to 40.96kWh (up to 16 units in parallel), offering you sufficient capacity to meet different requirements.

- APP Monitoring (optional)**
Real-time monitoring & Remote upgrade
- Module Design**
Flexible expansion
- Easy Installation**
Stackable with flexible brackets
- High Safety LFP**
Cell level monitoring and balancing
- Wide Compatibility**
Matching with leading inverters

- Lead-acid battery alternative**
Superior performance with longer lifespan
- Module Design**
Flexible expansion
- Easy Installation**
Small size and support wall mounting
- High Discharge Rate**
Support 1.3C discharge rate
- Multiple Communication Methods**
CAN/485/Wifi(Optional) communication

Technical Specifications

Model	DL5.0
Battery Type	LiFePO4
Nominal Battery Energy	5.12 kWh
Nominal Capacity	100Ah
Nominal Voltage	51.2V
Operating Voltage	44.8 ~ 57.6V
Recommended Charge & Discharge C Rate	0.5C
Recommended Charge/Discharge Current	50A
Max.Continuous Discharge Current	100A(1C)
Max. Power Charge Current	75A
Peak Power Charge/Discharge Current	110A (15s)
Depth of Discharge (DOD)	90%
Net Weight	44 kg
Dimension[W*D*H]	481*535*140 mm
Charging Temp. Range	0~55°C
Discharging Temp. Range	-20~55°C
Communication	CAN/RS485/RS232
Cycle Life ^[1]	≥6000 Cycles
Protection Level	IP20
Expansion	Up to 50 units in parallel
Pros	Can be used in both off-grid and hybrid setups, compact design
Certification & Safety Standard	UN38.3/CE-EMC/IEC62619
Compatible Inverters	SMA/Victron/Ingeteam/Delios/Goodwe/Solis/Deye/SAJ/Voltronic/Sungrow etc.

[1]Test conditions: 0.2C Charging/Discharging, @25°C, 90% DOD

Technical Specifications

Model	DL2.5
Cell Technology	LiFePO4
Battery Module Capacity	2.56 kWh
Battery Module Voltage	25.6 Vdc
Battery Module Capacity	100 Ah
Battery Module Cell Quantity	8 pcs
Battery Cell Capacity	320 Wh
Battery Cell Voltage	3.2 Vdc
Battery Cell Capacity	100 Ah
Battery Module Cell Quantity in Series	8 pcs
Battery Module Charge Voltage	28.5 Vdc
Battery Discharge Current	50 A (recommended) / 130 A (max 30min)
Battery Charge Current	50 A (recommended) / 75 A (max 40min)
Depth of Discharge (DOD)	90%
Cycle Life ^[1]	≥6000
Dimension(W*D*H, mm)	481*221*133mm
Communication	CAN/RS485/Wifi (Optional)
Pollution Degree (PD)	II
IP Grade	IP20
Weight	23 kg
Working temperature	Charging 0°C~+55°C / Discharging -20°C~+55°C
Humidity	5%~85% RH (No condensation, system work well.)
Storage temperature	-10°C~+35°C

[1]Test conditions: 0.2C Charging/Discharging, @25°C, 90% DOD



A48100

This 4.8kWh LFP module supports both floor-standing and wall-mounted installations. It is equipped with OTA function for remote upgrade and monitoring. Up to 30 modules in parallel, it can meet various needs of users and enable flexible expansion.



APP Monitoring (optional)

Real-time monitoring & Remote upgrade



Module Design

Flexible expansion



High Safety LFP

Cell level monitoring and balancing



Various Mounting Methods

Wall-mounted, floor-standing and stacked



Wide Compatibility

Matching with leading inverters

Technical Specifications

Model	A48100
Battery Type	LiFePO4
Nominal Battery Energy	4.8 kWh
Nominal Capacity	100Ah
Nominal Voltage	48V
Operating Voltage	42 ~ 54V
Recommended Charge & Discharge C Rate	0.5C
Recommended Charge/Discharge Current	50A
Max. Power Charge/Discharge Current	75A
Peak Power Charge/Discharge Current	100A (15s)
Depth of Discharge (DOD)	90%
Net Weight	45 kg
Dimension[W*D*H]	504*597*155 mm
Charging Temp. Range	0~55°C
Discharging Temp. Range	-20~55°C
Communication	CAN/RS485/RS232
Cycle Life ^[1]	≥6000 Cycles
Protection Level	IP20
Expansion	Up to 30 units in parallel
Pros	Can be used in both off-grid and hybrid setups, compact design
Certification & Safety Standard	UN38.3/CE-EMC/IEC62619/IEC60730/CEI-021/GOST-R/UKCA
Compatible Inverters	SMA/Victron/Ingeteam/Delios/Goodwe/Solis/Deye/SAJ/Voltronic/Sungrow etc.

[1]Test conditions: 0.2C Charging/Discharging, @25°C, 90% DOD



DL5.0C

Dyness DL5.0C adopts economic design, and is tailor-made for residential and small commercial application. This LFP battery module supports remote upgrade and APP monitoring, and provides multiple installation methods. It is scalable from 5.12kWh to 256kWh (max. 50 modules in parallel), providing various energy options to meet different requirements.



APP Monitoring (optional)

Real-time monitoring & Remote upgrade



Support Battery Charge (optional) & Discharge under low ambient temperature

Wall-mounted, floor-standing and stacked, flexible expansion



Various Mounting Methods



High Safety LFP

Cell level monitoring and balancing



Wide Compatibility

Matching with leading inverters

Technical Specifications

Model	DL5.0C
Battery Type	LiFePO4
Nominal Battery Energy	5.12 kWh
Nominal Capacity	100Ah
Nominal Voltage	51.2V
Operating Voltage	44.8 ~ 57.6V
Recommended Charge & Discharge C Rate	0.5C
Maximum Discharge C rate	1C
Recommended Charge/Discharge Current	50A
Max. Power Charge/Discharge Current	Charge 75A Discharge 100A
Peak Power Charge/Discharge Current	110A (15s)
Depth of Discharge (DOD)	90%
Net Weight	54 kg
Dimension[W*D*H]	558*545*150 mm
Charging Temp. Range	0~55°C/-20~55°C (with heating function)
Discharging Temp. Range	-20~55°C
Communication	CAN/RS485/RS232
Cycle Life ^[1]	≥6000 Cycles
Protection Level	IP20
Expansion	Up to 50 units in parallel
Pros	Can be used in both off-grid and hybrid setups, compact design
Certification & Safety Standard	UN38.3/CE-EMC/IEC62619/CEI-021
Compatible Inverters	SMA/Victron/Ingeteam/Delios/Goodwe/Solis/Deye/SAJ/Voltronic/Sungrow etc.

[1]Test conditions: 0.2C Charging/Discharging, @25°C, 90% DOD

PowerDepot H5B



PowerDepot H5B is a low-voltage product designed for residential application. The reliable lithium iron phosphate (LFP) technology ensures maximum safety and longer cycle life. It can be used flexibly for self-consumption and backup applications with a wide capacity range scalable from 5.12kWh to 25.6 kWh, to meet various energy storage needs.



APP Monitoring (optional)
Real-time monitoring & Remote upgrade



High protection level
Indoor & outdoor options



Various Mounting Methods
Wall-mounted or floor-standing installations



High Safety
LFP & smart BMS



Wide Compatibility
Matching with leading inverters

Technical Specifications

Model	PowerDepot H5B
Battery Type	LiFePO4
Nominal Battery Energy	5.12 kWh
Operating voltage	44.8 ~ 57.6V
Nominal Voltage	51.2V
Nominal Capacity	100Ah
Max. output power	3.84kW
Recommended Charge & Discharge C Rate	0.5C
Recommended Charge/Discharge Current	50A
Recommended Depth of Discharge (DOD)	90%
Net Weight	55 kg
Dimension[W*D*H]	574*228*600 mm
Charging Temp. Range	0 ~ 55°C/-20 ~ 55°C (with heating function)
Discharging Temp. Range	-20~55°C
Communication	CAN/RS485/RS232
Cycle Life ^[1]	≥6000 Cycles
Protection Level	IP65
Expansion	Up to 5 units in parallel
Color	White
Alarms	Overcharge/Over-discharge/Overcurrent/Overtemperature/Short Circuit
Monitoring & Protection	Each system has smart BMS, breaker embedded in system
Pros	Can be used in both off-grid and hybrid setups, compact design, floor or wall-mounted
Certification & Safety Standard	UN38.3/CE-EMC/IEC62619/IEC62040/IEC60730/GOST-R/UKCA/CEC Accredited
Compatible Inverters	SMA/Victron/Ingeteam/Delios/Goodwe/Solis/Deye/SAJ/Voltronic/Sungrow etc.

[1] Test conditions: 0.2C Charging & Discharging, @25°C, 90% DOD

Powerbox Pro



The Powerbox Pro is a type of deep cycle and high capacity LFP battery with improved safety, long lifespan, and optimized user experience. It is especially designed with IP65 for more flexible and easier installation indoor or outdoor with wall-mounted and landed installation options. With up to 10 kWh for a single unit and max. 5 units in parallel with superior performance, it can meet the household electricity demand. Get ready with Powerbox Pro for super power storage for your life.



APP Monitoring (optional)
Real-time monitoring & Remote upgrade



High protection level
Indoor & outdoor options



Various Mounting Methods
Wall-mounted or floor-standing installations



High Safety LFP
LFP & smart BMS



Wide Compatibility
Matching with leading inverters

Technical Specifications

Model	Powerbox Pro
Battery Type	LiFePO4
Nominal Battery Energy	10.24 kWh
Operating Voltage	44.8 ~ 57.6V
Nominal Voltage	51.2V
Nominal Capacity	200Ah
Nominal Power	5.12kW
Peak Power	10.24kW
Recommended Charge & Discharge C Rate	0.5C
Recommended Charge/Discharge Current	100A
Recommended Depth of Discharge (DOD)	90%
Net Weight	103 kg
Dimension[W*D*H]	555*210*928 mm
Charging Temp. Range	0~55°C
Discharging Temp. Range	-20~55°C
Communication	CAN/RS485/RS232
Cycle Life ^[1]	≥6000 Cycles
Protection Level	IP65
Expansion	Up to 5 units in parallel
Color	White
Alarms	Overcharge/Overdischarge/Overcurrent/Overtemperature/Short Circuit
Pros	Can be used in both off-grid and hybrid setups, compact design, floor or wall-mounted
Certification & Safety Standard	UN38.3/CE-EMC/IEC62619/IEC62040/IEC60730/UKCA/CEC Accredited
Compatible Inverters	SMA/Victron/Ingeteam/Delios/Goodwe/Solis/Deye/SAJ/Voltronic/Sungrow etc.

[1] Test conditions: 0.2C Charging & Discharging, @25°C, 90% DOD



The DYNESS battery PowerBrick module is widely used in energy storage sector. It adopts modular design and can be used for residential applications. The reliable LiFePO4 technology ensures maximum safety and a longer life cycle.

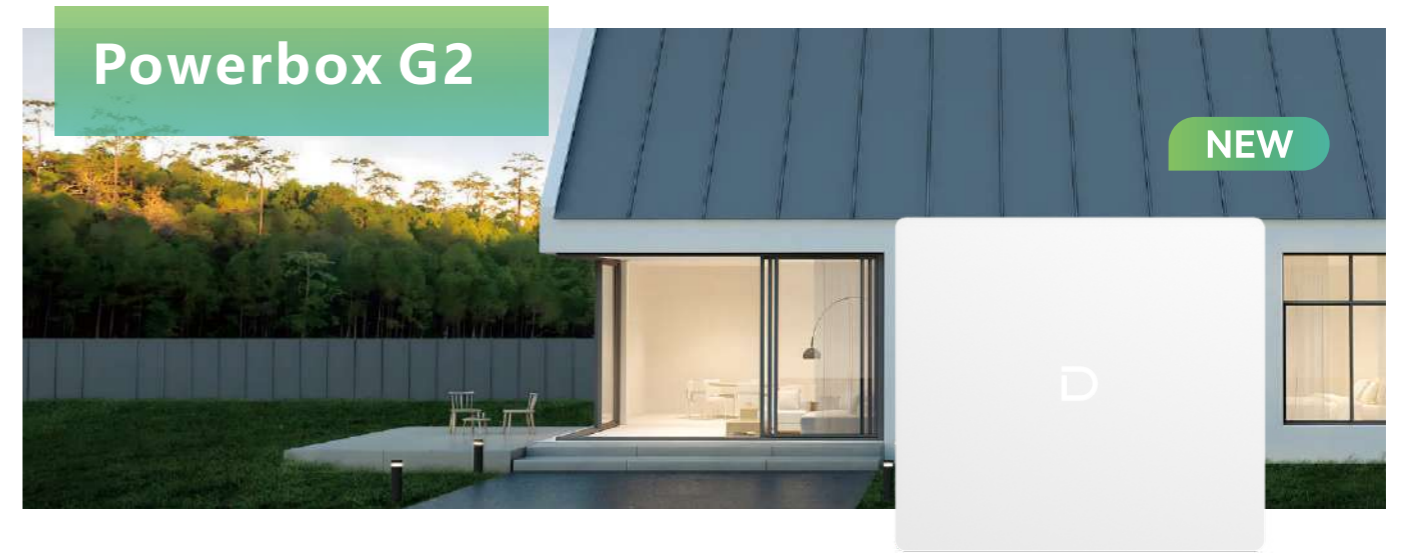

The Powerbox G2 is a type of deep cycle and high capacity LFP battery with improved safety, long lifespan, and optimized user experience. It is especially designed with IP65 for more flexible and easier installation indoor or outdoor with wall-mounted and landed installation options. With up to 10 kWh for a single unit and max 12 units in parallel with superior performance, it can meet the household electricity demand. Get ready with Powerbox G2 for super power storage for your life.

- 
 Compared to the previous generation, the size is reduced by 24%, and the capacity increases by 40%
- 
 Continuous discharge current 200A, maximum continuous discharge power 10kW
- 
 Fire Protection System: Optional Aerosol fire extinguisher
- 
 Unlimited Cycles / 10 Years
- 
 Maximum can be expanded to 716.8kWh (no HUB)

- 
 Lighter and Smaller
15% weight reduction, 30% volume reduction
- 
 Build in Active fire protection system
- 
 Unlimited Cycles / 10 Years warranty
- 
 -20 degrees low temperature charging function
 Battery low temperature heating function (optional)

Technical Specifications

Model	PowerBrick
Battery Type	LiFePO4
Nominal Battery Energy	14.336kWh
Nominal Voltage/Capacity	51.2V/280Ah
Recommended Charge/Discharge Current	140A (0.5C)
Max. Charge Current	200A
Max. Discharge Current	200A
Depth of Discharge	95%
Communication	CAN/RS485
Cycle Life ^[1]	Unlimited cycles / 10 Years
Protection Level	IP20
Net Weight	114Kg
Dimension[W*D*H]	435*233*857mm (No wall-mounted bracket)
Maximum Parallel Modules	50
Charging Temp. Range	0 ~ 55°C
Discharging Temp. Range	-20 ~ 55°C
WIFI Module	Built-in WIFI module; APP OTA function
Fire Protection System	Optional Aerosol fire extinguisher
Certification & Safety Standard	UN38.3; CE
Compatible Inverters	SMA/Victron/ngeteam/Delios/Goodwe/Solis /Deye/SAJ/Voltronic/Sungrow etc

[1]Test conditions: 0.2C Charging/Discharging, @25°C, 95% DOD

Technical Specifications

Model	Powerbox G2
Battery Type	LiFePO4
Nominal Battery Energy	10.24kWh
Usable Energy	9.728kWh
Operating Voltage	44.8-57.6V
Nominal Voltage	51.2V
Nominal Capacity	200Ah
Nominal Charge or Discharge Power	5.12kW
Max Discharge Power	10.24kW
Recommended Charge & Discharge C Rate	0.5C
Max Discharge C Rate	1C
Recommended Charge/Discharge Current	100A
Max Discharge Current	200A
Recommended Depth of Discharge (DOD)	95%
Net Weight	95kg without glass front panel; 98Kg with glass front panel
Dimension[W*D*H]	710*165*640mm
Charging Temp. Range	0 ~ 55°C/-20 ~ 55°C (with heating function)
Discharging Temp. Range	-20~55°C
Communication	CAN/RS485
Cycle Life ^[1]	Unlimited cycles / 10 Years
Protection Level	IP65
Expansion	Up to 12 units in parallel
Color	White
WIFI Module	Built-in WIFI module; APP, OTA function
Battery low temperature heating function	Optional
Active fire protection system	Built-in aerosol fire extinguisher
Certification & Safety Standard	UN38.3, IEC62619, IEC62040, CEC, CE RED
Compatible Inverters	SMA/Victron/Ingeteam/Delios/Goodwe/Solis /Deye/SAJ/Voltronic/Sungrow etc.

[1]Test conditions: 0.2C Charging/Discharging, @25°C, 95% DOD

Reliable High Voltage Home Energy Storage Systems

192V~576V

Tower T7/T10/T14/T17/T21

Tower Pro-TP7/TP11/TP15/TP19/TP23

7.1-23.04kWh/Set

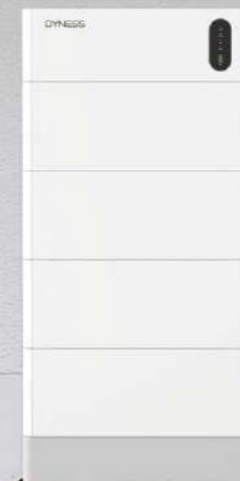



The upgraded Tower Series is tailor-made for large residential application. Stackable design with self-adaptive modules, five energy choices of up to 21.31kWh with parallel connection available, advanced LiFePO4 technology, remote upgrade, high waterproof level and good cooling function... Whatever you need, Dynness Tower Series is there to meet your requirements.



Dynness Tower Pro Series with IP55 protection level offers multiple energy options through an expandable modular design (2-6 modules combined), and the expandable parallel connection of up to 12 clusters allows for a maximum capacity of 276.48 kWh. The stackable auto-configuration modules make the system easier to install and maintain. Tower Pro also offers an optimized user experience with ultra-rapid charge (1C), LED display on the BDU, and remote upgrade and monitoring.



APP Monitoring (build-in wifi)
Real-time monitoring & Remote upgrade



Self-adaption Auto configuration



Easy Installation
Stackable design, wireless connection



High Protection Level
Indoor & outdoor installations



Wide Compatibility
Matching with leading inverters

Technical Specifications

Model	Tower T7	Tower T10	Tower T14	Tower T17	Tower T21
Battery Module Type	LiFePO4	LiFePO4	LiFePO4	LiFePO4	LiFePO4
Battery Module Quantity	2	3	4	5	6
Nominal Energy	7.10 kWh	10.66 kWh	14.21 kWh	17.76 kWh	21.31 kWh
Usable Energy	6.745kWh	10.127kWh	13.499kWh	16.872kWh	20.245kWh
Operating Voltage	168 ~219V	252 ~ 328V	336 ~ 438V	420 ~ 547V	504 ~ 657V
Nominal Voltage	192V	288V	384V	480V	576V
Nominal Capacity	37Ah	37Ah	37Ah	37Ah	37Ah
Max. Continuous Charge/Discharge Power ^[1]	4.26 kW	6.39 kW	8.52 kW	10.65 kW	12.78 kW
Recommended Depth of Discharge (DOD)	95%	95%	95%	95%	95%
Dimensions [W*D*H](mm)	504*380*700	504*380*900	504*380*1100	504*380*1300	504*380*1500
Net Weight [kg]	105 kg	146 kg	187 kg	228 kg	269 kg
Charging Temperature Range	0~50°C				
Discharging Temperature Range	-10~50°C				
Communication	CAN/RS485				
Cycle life ^[2]	≥6000 Cycles				
Protection Level	IP54				
Color	White				
Alarms	Overcharge/Overdischarge/Overcurrent/Overtemperature/Short Circuit				
Pros	Can be used in both off-grid and hybrid setups, compact design, modular expansion				
Battery Module Name	HV9637				
Expansion	Max. 12 towers can be connected in parallel				
Certification	UN38.3/CE-EMC/IEC62040/IEC62619/IEC62477/IEC60730/IEC63056/UKCA/CEC Accredited/UL1973/VDE2510-50				
Compatible Inverters	Ingeteam/Kostal/Goodwe/Solis/SAJ/Sinexcel/Atess/Deye/Sunways/Ecactus etc.				

[1]Maximum Continuous Discharge/Charge Power when communicating with inverter is 0.6C
[2]Test conditions: 0.2C Charging& Discharging, @25°C, 95% DOD



Equipped with aerosol fire extinguisher



1C rate charge/discharge



Easy to install: Stackable auto-configuration modules, wireless connection



High Protection Level: Indoor & outdoor installations



Heating function (Optional)

Technical Specifications

Model	Tower Pro TP7	Tower Pro TP11	Tower Pro TP15	Tower Pro TP19	Tower Pro TP23
Battery Module Type	LiFePO4	LiFePO4	LiFePO4	LiFePO4	LiFePO4
Battery Module Quantity	2	3	4	5	6
Rated Energy	7.68 kWh	11.52 kWh	15.36 kWh	19.2 kWh	23.04 kWh
Usable Energy	7.296 kWh	10.944 kWh	14.592 kWh	18.24 kWh	21.888 kWh
Operating Voltage	168 ~219V	252 ~ 328V	336 ~ 438V	420 ~ 547V	504 ~ 657V
Nominal Voltage	192V	288V	384V	480V	576V
Nominal Capacity	40Ah	40Ah	40Ah	40Ah	40Ah
Max. Continuous Charge/Discharge Power ^[1]	7.68 kW	11.52 kW	15.36 kW	19.2 kW	23.04 kW
Recommended Depth of Discharge (DOD)	95%	95%	95%	95%	95%
Dimensions [W*D*H]	587*310*788 mm	587*310*1009 mm	587*310*1230 mm	587*310*1451 mm	587*310*1672 mm
Net Weight [kg]	99.5 kg	135 kg	170.5 kg	206 kg	241.5 kg
Charging Temperature Range	0~55°C/-20~55°C (with heating function)				
Discharging Temperature Range	-20~55°C				
Communication	CAN/RS485/RS232				
Cycle life ^[2]	≥8000 Cycles				
Protection Level	IP55				
Warranty	10 /15 Years (Optional)				
Heating Function	PTC Heating (Optional)				
Fire Protection Function	Aerosol fire extinguishing				
OTA Remote Upgrade Function	Equipped				
Battery Module Name	HV9640				
Expansion	Max. 12 Tower Pro can be connected in parallel				
Certification	UN38.3/VDE2510-50/IEC62619/IEC63056/IEC62477/IEC62040/CE-EMC/ROHS				
Compatible Inverters	Ingeteam/Kostal/Goodwe/Solis/SAJ/Sinexcel/Atess/Deye/Sunways/Ecactus etc.				

[1]Maximum Continuous Discharge/Charge Power when communicating with inverter is 1C
[2]Test conditions: 0.2C Charging& Discharging, @25°C, 95% DOD

Energy Guarantee For Outdoor Activities

RV12100



Dyness RV12100 is tailor-made for outdoor travel. It adopts the most advanced LiFePO4 technology and built-in smart BMS, ensuring superior performance and long cycle life. Up to 16 modules in parallel, it offers you sufficient energy options to meet different requirements.



High Safety
LFP & smart BMS



Wide Application
Applied in kinds of RVs



Compact Design
Light weight & small size



Wide Temperature Range
Range of -20~55°C

Technical Specifications

Model	RV12100
Battery Type	LiFePO4
Nominal Battery Energy	1.28 kWh
Nominal Capacity	100Ah
Nominal Voltage	12.8V
Operating Voltage	11.2 ~ 14.6V
Recommended Charge & Discharge C Rate	0.5C
Recommended Charge/Discharge Current	50A
Max. Power Charge/Discharge Current	75A
Peak Power Charge/Discharge Current	100A (15S)
Depth of Discharge (DOD)	90%
Net Weight	14 kg
Dimension[W*D*H]	306*183*185 mm
Charging Temp. Range	0~55°C
Discharging Temp. Range	-20~55°C
Communication	CAN/RS485
Cycle Life ^[1]	≥6000 Cycles
Protection Level	IP20
Expansion	Up to 16 units in parallel
Pros	Used as electricity power for RV
Certification & Safety Standard	UN38.3
Compatible Inverters	Steca/MUST/Victron

[1] Test conditions: 0.2C Charging/Discharging, @25°C, 90% DOD

Why Choose Dyness Energy System?



Monitor Your System with Dyness Smart APP and Website

Monitor Your System with Dyness APP

Download the Dyness Smart App in App Store or Google Play, User can monitor battery SOC, energy, etc. in real-time.

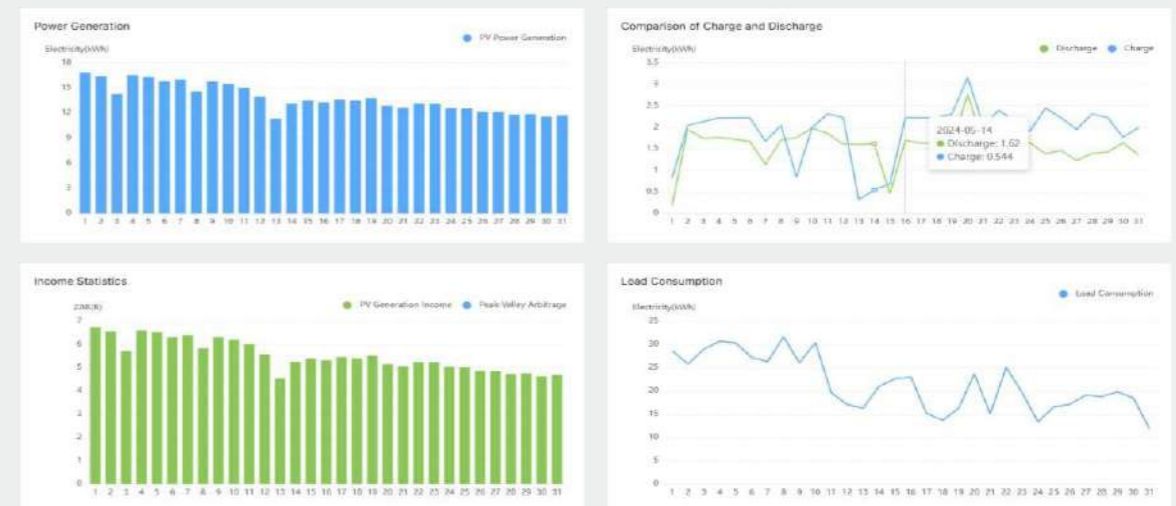
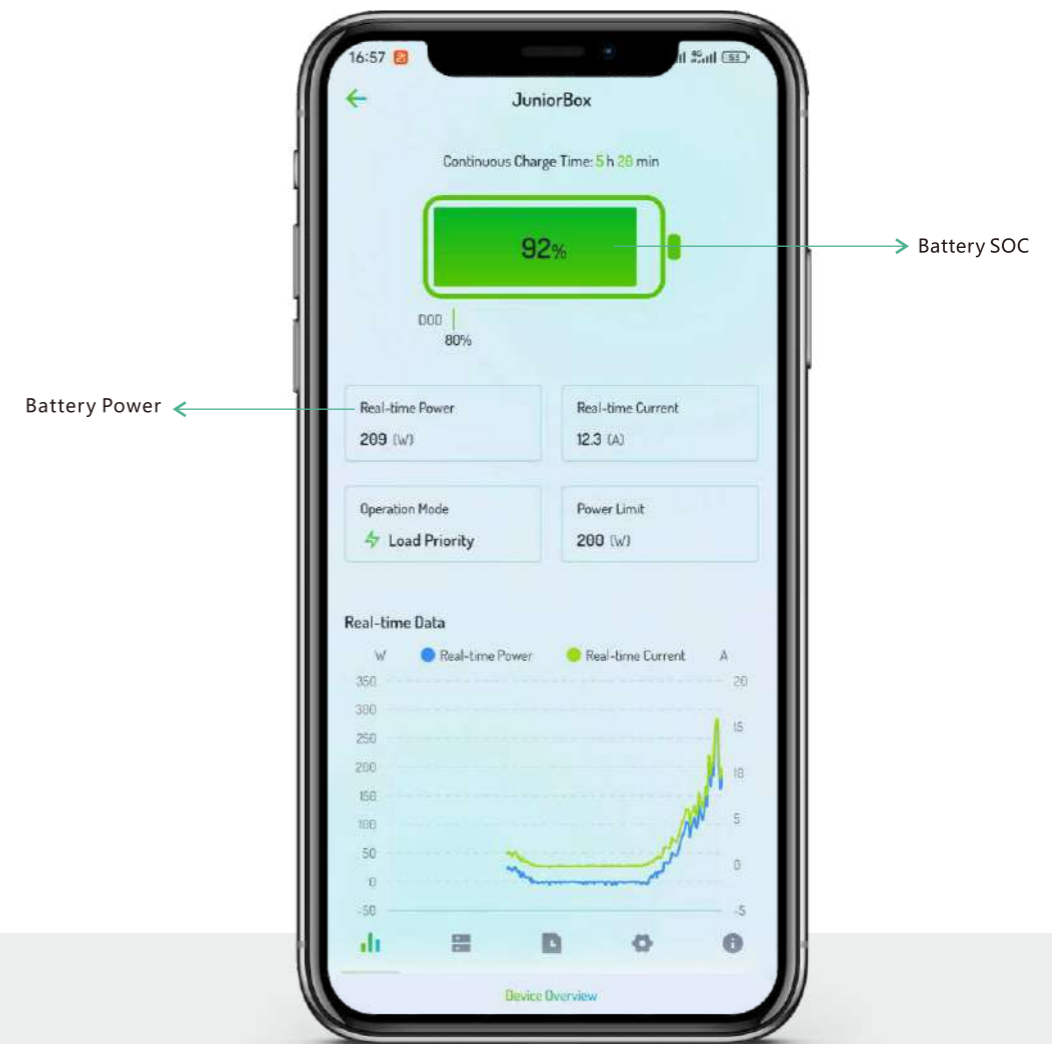

Plant Energy and Revenue Statistics

Monitor Your System with Dyness Website

User can monitor battery SOC, energy, etc. in real-time via website as well.

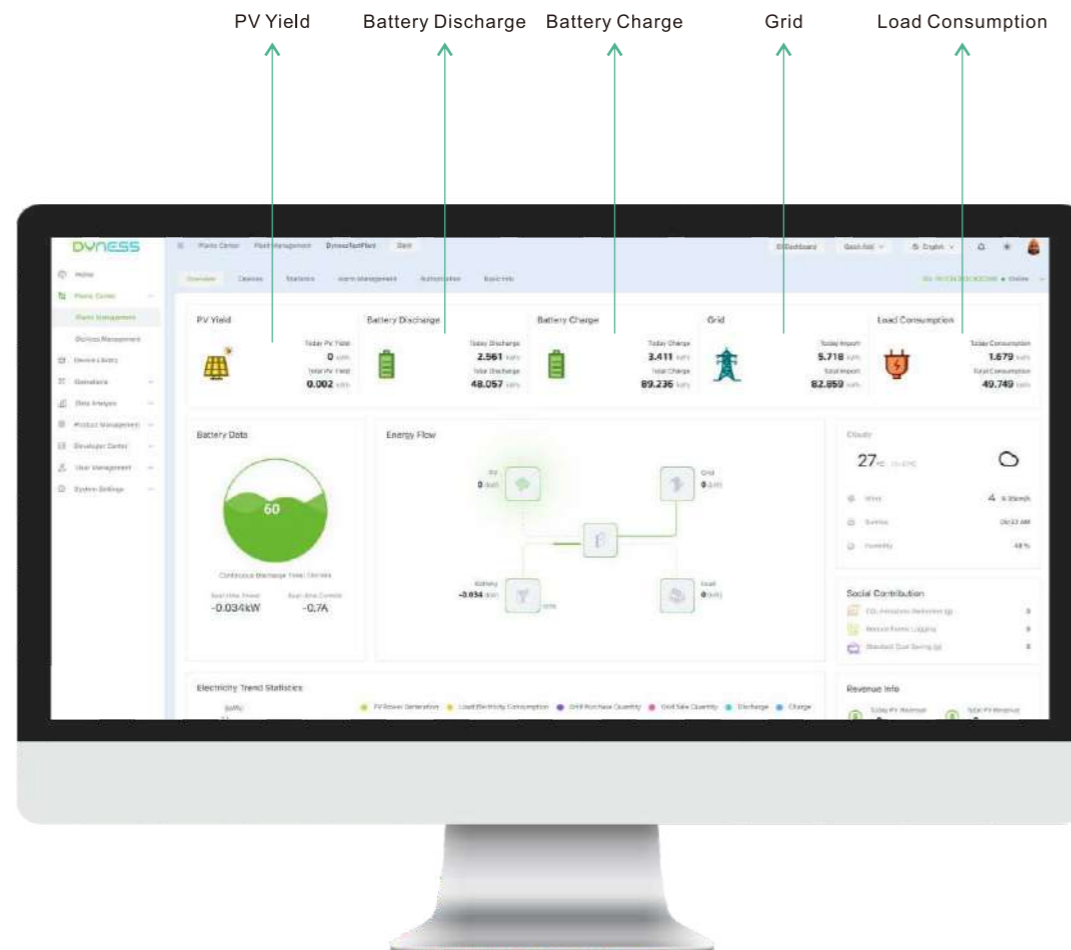

Energy Trend in the Past 24 Hours

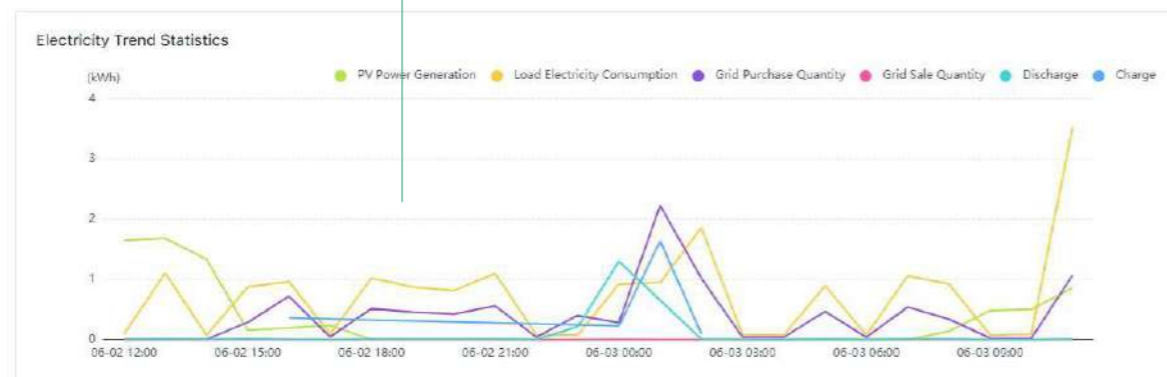

Enhance Self-Sufficiency, Reduce Electricity Bills

Self-Consumption Mode

Dyness battery system integrates a smart self-control logic to maximize solar energy self-consumption, thus to reduce grid consumption. Solar powers house loads first, and keep its production ability to charge battery, which will be used to supply home when solar is weak.

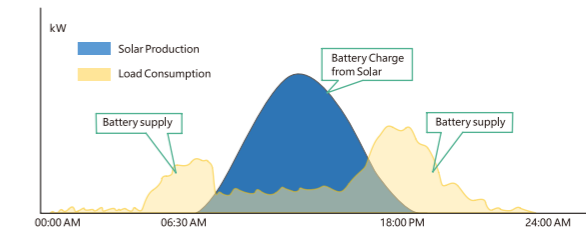

Solar Maximization: Solar Overloading

Solar Overloading ability allows solar produce higher power than inverter capacity. Users could put much more panels on his roof to support load on AC side and charge battery on DC side together, thus to reduce the waste of exceeded solar capacity during a sunny day.



Time-Of-Use Mode: Battery Makes Your Solar Worth More

Used in TOU mode, battery supports solar power be stored during Off-Peaks and discharge during On-Peaks, which makes solar power a higher value.

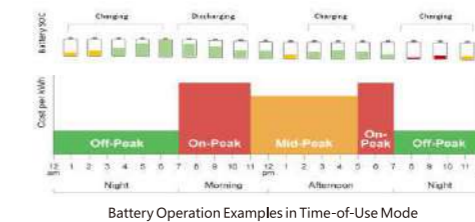

Storage Contribution

Battery is an essential path to reduce home electricity bills by reducing power consumption from utility, as well to provide a cheaper power source during On-Peaks.



Protections From Power Shortage or Blackouts

Dyness battery system store solar energy, to provide power supply during blackouts. Fit for specific house consumption demand start from 2.4kWh for low voltage battery system and 7kWh to 92.16kWh for high voltage battery systems.

Dyness batteries are designed for power backup operations and off-grid solutions.

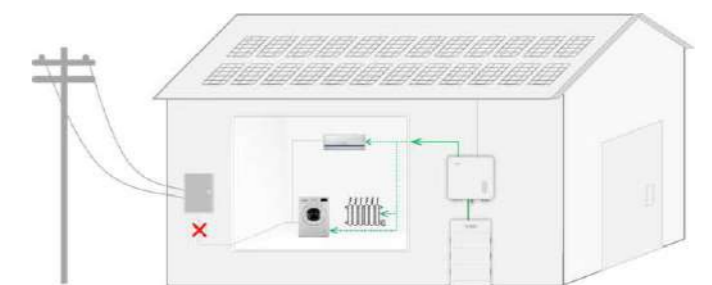

Dyness Solution Features

Various Options

Dyness solutions covers various scenarios, including indoor & outdoor use, low voltage & high voltage packs, and various capacity options from 2.4kWh to more than 30kWh etc., to diversify battery pack design. Dyness has the ambition to be able to provide storage solutions for all houses.

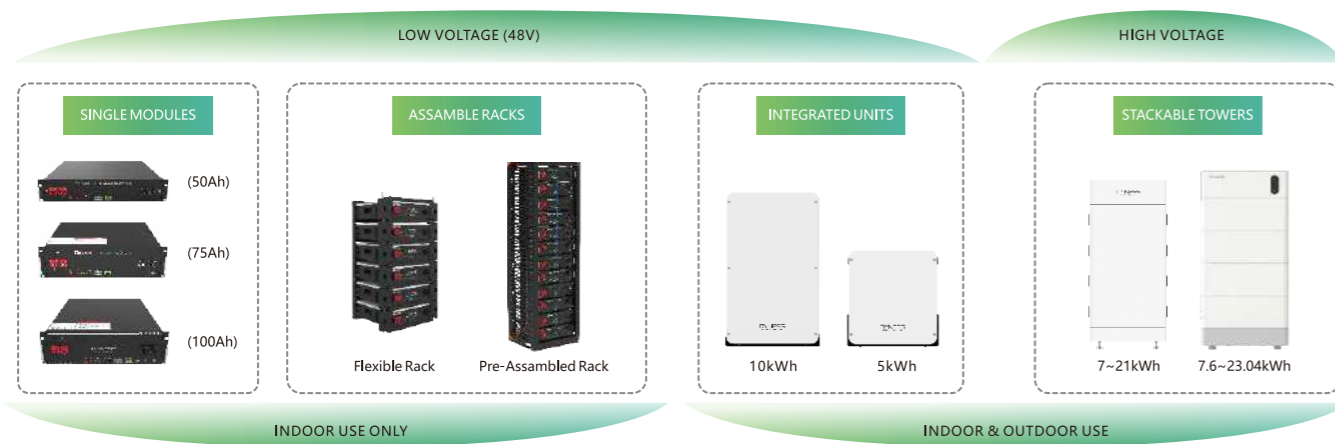

Flexible Energy Extension

Dyness battery modules are designed to allow users extend your system capacity as house power demand might increase, or as you plan to use more clean energy by increase house solar self-consumption rate. You will have easy access to the details of energy extension in user manual or contacting Dyness.



System Paralleling

Dyness DC BUS Box is designed for battery system paralleling, by which the battery capacity could be extended further.

DC BUS Box are designed for different battery modules:

Battery	DC BUS Box	Max Battery Units
TOWER / TOWER Pro	DCB-TW	12
HV Rack	DCB-HV	12 Racks
LV Rack	Customized	<40 Modules
Power Box Pro & Power Deport H5B	Customized	5

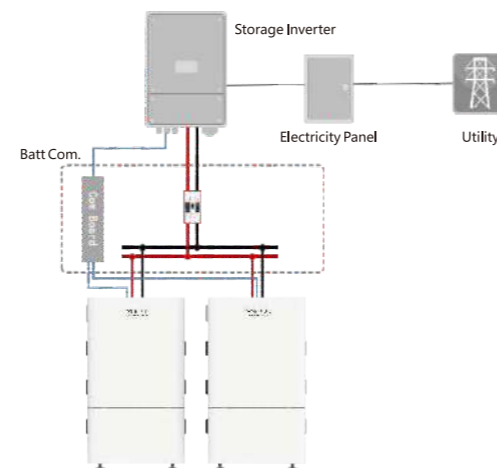

Reduce Soft Cost - Installer Friendly

Installation contributes to a big part of system soft cost. An easy installation design helps much to reduce whole system costs. Dyness battery is designed to reduce installation & commissioning time, and prevent fault installations as well.

Easy Energy Extension

Dyness provides a flexible rack solution for 50Ah, 75Ah and 100Ah low voltage battery modules, which makes system layout more flexible and energy extension easier.

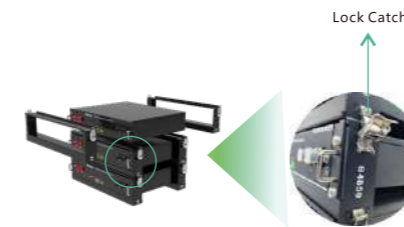

Easy Installation

Dyness Tower T series are designed to enable plug & play installation to reduce installation time and minimize mis-operations.

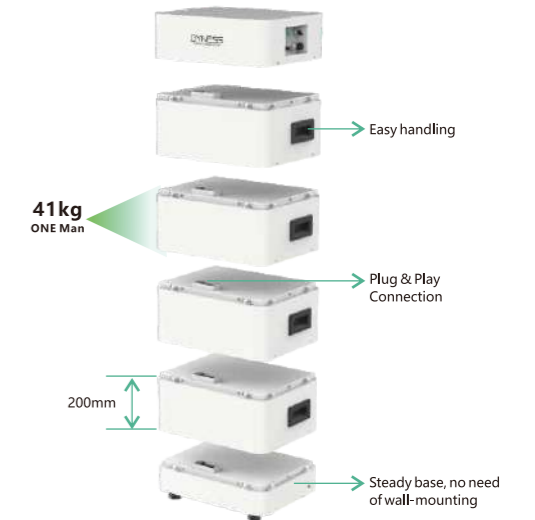

Considerate Design - User Friendly

House Fit-In

Dyness select white color for its outdoor-used battery packs and have a good control on battery size to make sure that they are able to fit in most house styles and suitable for various installation spaces like garage or basement.



Convenient User Interface

Dyness battery has OTA function to allow users to check battery operations on smart phone and laptop both locally and remotely.

